

# VELIS 62 WC MONOBLOCCO SCOCCA

**CATALANO**  
THE ESSENCE OF CERAMICS

cod. 1MPVL00

Wc monoblocco 4,5-3 lt. scarico a parete trasformabile a terra tramite curva tecnica.

Monobloc WC outlet to wall 4,5-3 lt. Commutable in outlet to floor by a pipe fitting.

Stand-kombination-wc mit Wandabfluss, durch Kurventechnik auf Bodenabfluss umrüstbar. 4,5 lt

cod. 1SCVL00

Scocca in ceramica.

Ceramic body shell.

Keramikbecken.

cod. 5BSSC00

Cisterna anticondensa con meccanismo di scarico dual flush 3/4,5 lt.

Anti-condensation plastic tank with dual-flush device 3/4,5 lt.

Kondensatauffangwanne mit 2-Mengen-Spültechnik zu 3/4,5 l.

cod. 5KRBSZ00

Kit raccordo per alimentazione cassetta.

Pipe fittings kit for cistern feeding.

Anschlussgarnitur für Spülkastenversorgung.

cod. 5NLV5STF00

Sedile soft-close in resina inalterabile.

Soft-close Seat-cover made of unalterable resin.

WC-Sitz SoftClose aus beständigem Harz.



CE EN 997 - CL1 - 5A

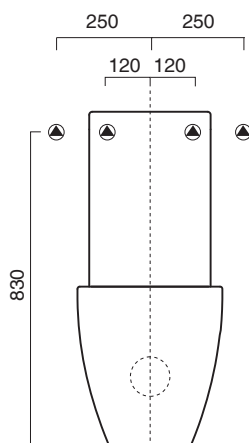
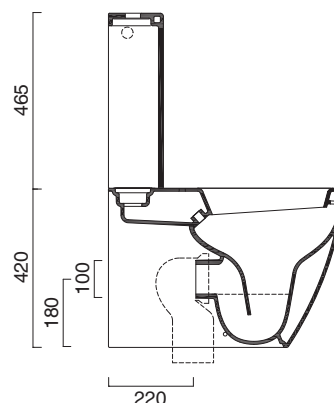
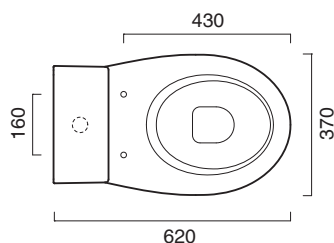

Tutti i diritti sulla presente scheda appartengono a Ceramica Catalano S.p.A. in via esclusiva. È vietata la copia, la pubblicazione, la distribuzione o la riproduzione (anche parziale), se non autorizzata per iscritto.  
All rights in the present form belong exclusively to Ceramica Catalano S.p.A. It is strictly forbidden to copy, publish, distribute or reproduce it (including any partial reproduction), without prior written permission.



**cod. 5CUIG00**

Curva di raccordo per scarico a pavimento.  
Connection elbow for floor outlet pipe.  
Pipe de raccordement sortie verticale.

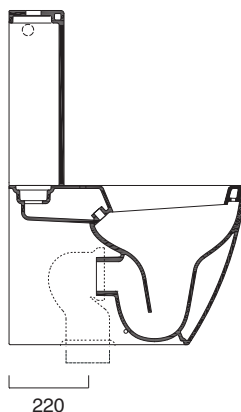

220



**cod. 5CU0200**

Set scarico regolabile da 7 a 13 cm + 17 fisso  
Adjustable discharge set, from 7 to 13 cm + 17 fixed  
Pipe de raccordement réglable de 7 a 13 cm + 17  
partie fixe.

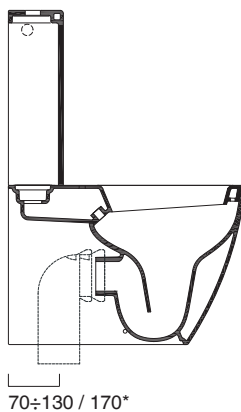

70±130 / 170\*

[\*] Distanza con l'utilizzo della curva  
senza raccordo orizzontale  
Dimension without using the horizontal pipe



**cod. 5CU0300**

Set scarico regolabile da 20 a 26 cm  
Adjustable discharge set from 20 to 26 cm  
Pipe de raccordement réglable de 20 à 26cm.

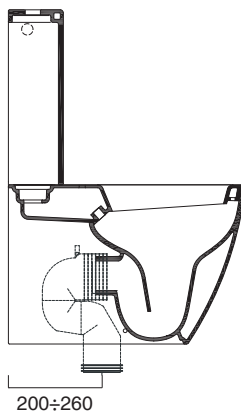

200±260

MADE IN ITALY

## GARANZIA

Il rivenditore sostituirà i prodotti con difetti di fabbricazione entro due anni dalla consegna.

*Your retailer will replace products with faults of manufacturing within two years from delivery date.*

*Der Wiederverkäufer wird Produkte mit Fabrikationsfehlern innerhalb 2 Jahren seit Zustellung ersetzen.*

## PULIZIA

Si consiglia di pulire con acqua tiepida e detersivo non abrasivo.

*The maintenance has to be done with tepid water and not abrasive detergents.*

*Für die Reinigung empfiehlt sich lauwarmes Wasser und keine Scheuermittel zu verwenden.*

## DICHIARAZIONE DI PERFORMANCE - DOP No 997

Scarica il documento al seguente link a lato:

*Click the link on the side to download the document:*

*Klicken Sie auf den Link zum Herunterladen des Dokuments:*

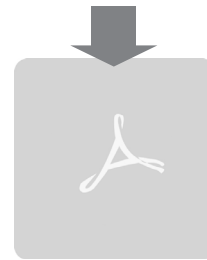

## WATER LABEL

Una nuova etichetta informativa accompagna i WC Catalano, attribuita e certificata dalla The Water Label Company. L'etichetta mostra una classificazione di performance, indicando il volume massimo d'acqua che il wc utilizza nella fase di scarico.

*All Catalano WCs have a new label, certified and issued by The Water Label Company. The label shows a performance ranking, indicating the maximum water volume of the toilet's flush.*

*Die Catalano-WCs besitzen eine neue Zertifizierung, die von der Water Label Company vergeben wird. Die Zertifizierung stellt eine Leistungsklassifizierung dar und gibt das maximale Wasservolumen an, das ein WC bei der Spülung verbraucht.*

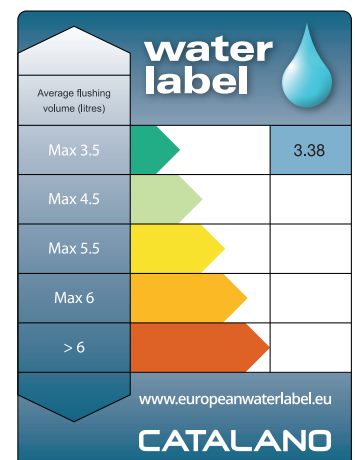

Antibacterial protection

**CATAglaze<sup>®</sup> + Silver Titanium**

**CATALANO**  
THE ESSENCE OF CERAMICS

MADE IN ITALY

L'INNOVATIVO SMALTO ANTIBATTERICO SU TUTTA LA CERAMICA  
THE INNOVATIVE ANTIBACTERIAL GLAZE IS STANDARD ON ALL  
CATALANO PRODUCTS.

L'ÉMAIL ANTIBACTÉRIEN NOVATEUR SUR TOUTE LA CÉRAMIQUE

**IT È un potenziamento dello smalto Cataglaze che, oltre a ridurre il deposito di calcare facilitando la pulizia dei sanitari ceramici, svolge una potente azione antimicrobica in grado di contrastare germi e batteri. L'efficacia della nuova formula è garantita dalla presenza nell'impasto di ioni d'argento e di titanio. L'azione antibatterica è certificata ISO 22196 con efficacia del 99,99%.**

**EN It is an improvement of Cataglaze glazing system; besides being more resistant to limescale and therefore easier to clean, it has a powerful antimicrobial action able to kill germs and bacteria. The effectiveness of the new formula is guaranteed by the presence in the mix of silver and titanium ions. The antibacterial action is ISO 22196 certified and it is 99.99% effective.**

**FR Il s'agit d'un renforcement de l'émail Cataglaze qui, en plus de réduire le dépôt de calcaire et donc faciliter le nettoyage des sanitaires en céramique, exerce une action antimicrobienne puissante en mesure de contraster les germes et les bactéries. L'efficacité de la nouvelle formule est garantie par la présence, dans le mélange, d'ions d'argent et de titane. L'action antibactérienne est certifiée ISO 22196 avec une efficacité de 99,99%.**



Silver Titanium  
Protezione antibatterica  
Silver Titanium  
Antibacterial protection  
Silver Titanium  
Protection antibactérienne

**99,99%**



Maggiore brillantezza  
Brightness  
Aspect brillant



Resistenza agli agenti chimici  
Resistance to chemicals  
Résistant aux agents chimiques



Rispetto per l'ambiente  
Respect for the environment  
Respect de l'environnement



Pulizia facile e rapida  
Quick cleaning  
Nettoyage rapide



Igiene totale  
Total hygiene  
Hygiène totale



Lunga durata di vita  
Long lifecycle  
Longue durée

Tutti i diritti sulla presente scheda appartengono a Ceramica Catalano S.p.A. in via esclusiva. È vietata la copia, la pubblicazione, la distribuzione o la riproduzione (anche parziale), se non autorizzata per iscritto. All rights in the present form belong exclusively to Ceramica Catalano S.p.A. It is strictly forbidden to copy, publish, distribute or reproduce it (including any partial reproduction), without prior written permission.